

The image shows a top-down view of a green felt surface. Scattered across the felt are numerous irregularly shaped paper cutouts. Some are a dark, muted blue color, while others are a light, natural wood-grain color. The cutouts are of various sizes and are scattered across the entire surface. The word "CLUSTER" is printed in a white, thin, sans-serif font on the right side of the image.

CLUSTER

MARKET RESEARCH

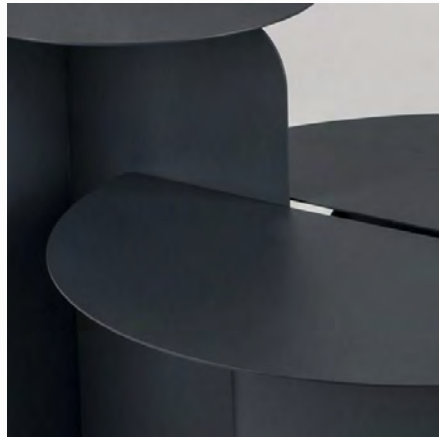

HIPHOP FORMAE ESTENSIONI

“One, two or three? These small tables with soft shapes fit together thanks to elegant cuts on each level. They can also be used separately.

Solid but lightweight, they fit perfectly into environments with a contemporary approach, reconceptualizing industrial style.”

MARKET RESEARCH



ETTORE FORMAE ESTENSIONI

“Ettore is an ash, steel and brass table, equipped with a shelf that can be placed at different heights according to your needs. The brass key placed on the edge is a functional and aesthetic element that gives the piece an elegant, refined look. Put this beautiful, practical table next to your favorite armchair, where you love to sit, check your tablet and sip a nice cup of tea.

CLUSTER

MARKET RESEARCH

ZHILONG ZHENG



MARKET RESEARCH

BASKET TABLES

MARIO TSAI



“Chinese furniture designer Mario Tsai has created a pair of tables with frames that allow them to be easily picked up and moved with one hand..”

MARKET RESEARCH

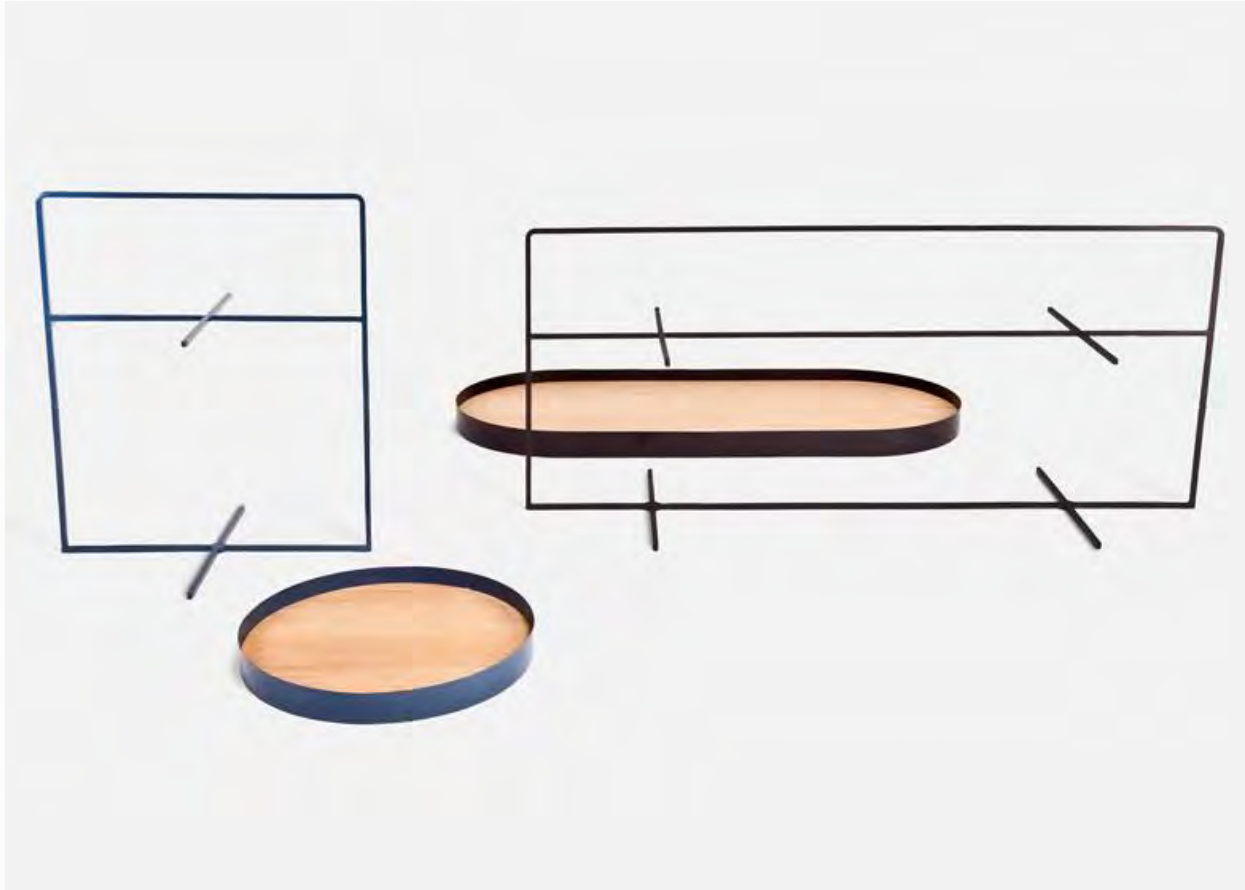

MARKET RESEARCH

SE01

JOHAN VILADRICH
ESTENSIONI



“The stool was designed with the idea to use an entire rectangular aluminum profile of 200x20mm. One piece uses a fifth of the profile and when five pieces are placed sides to sides they form a pentagon. The stools can then be stacked onto one another and form various spatial compositions.”

SKETCHES

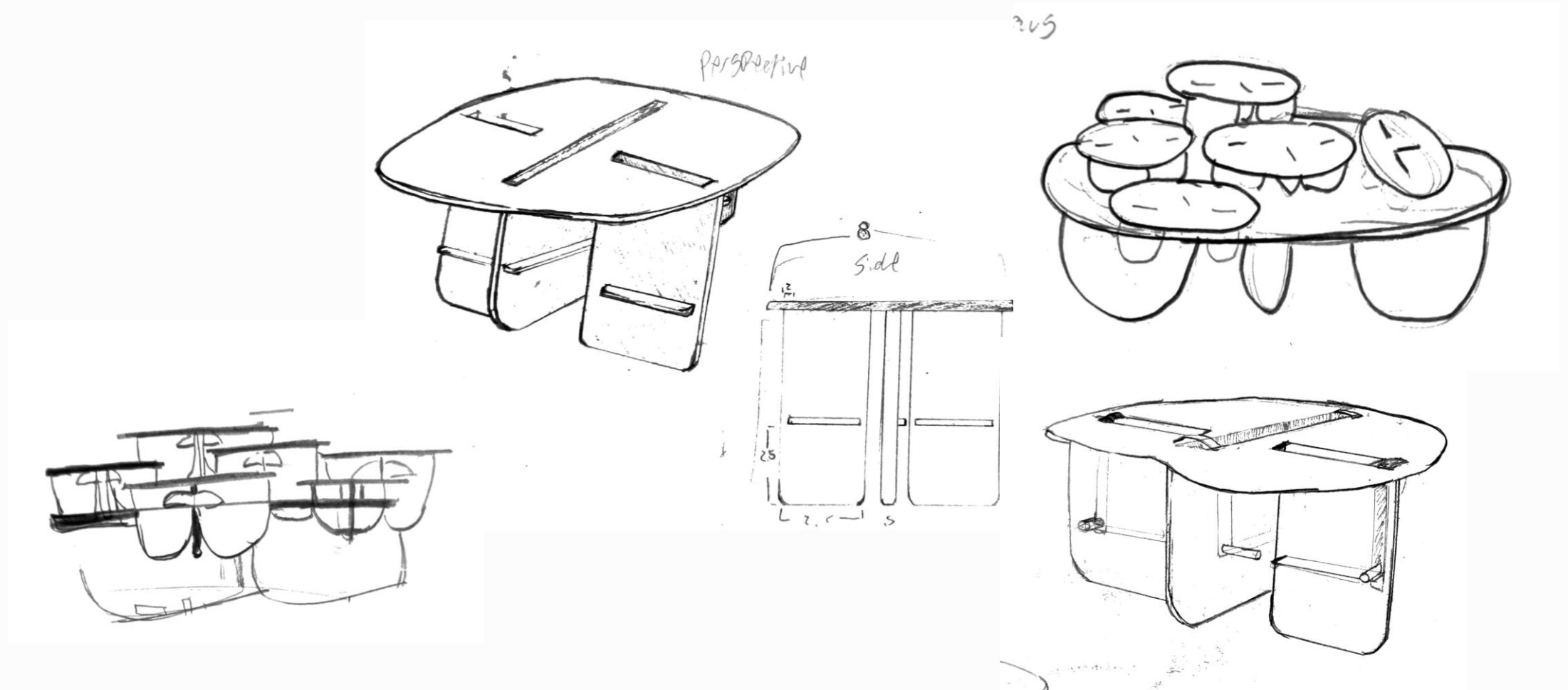

INSPIRATION

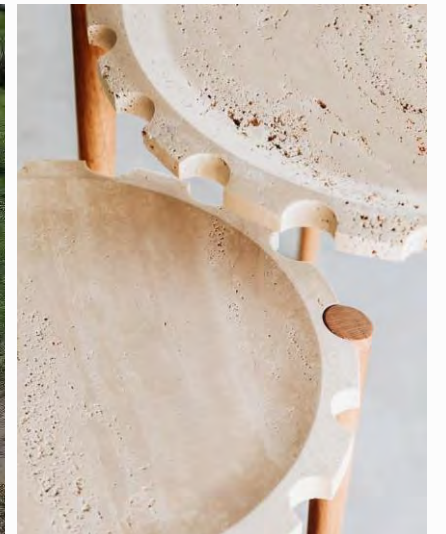
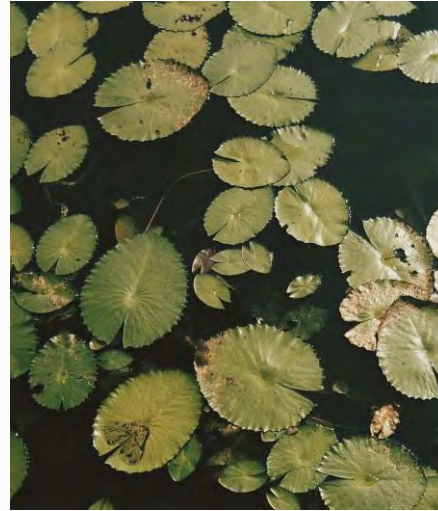

SMALL TABLE

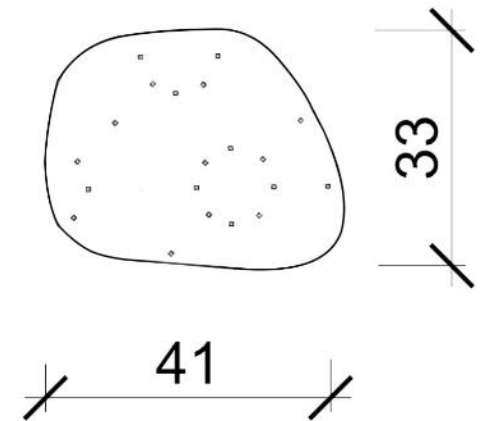
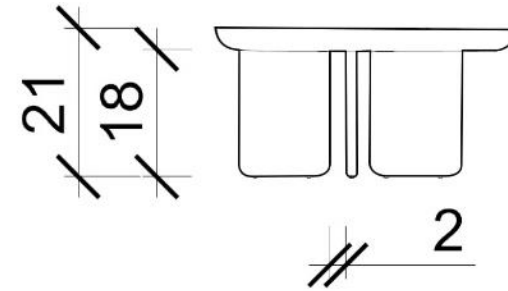

Stacking table

CLUSTER

BEDSIDE TABLE

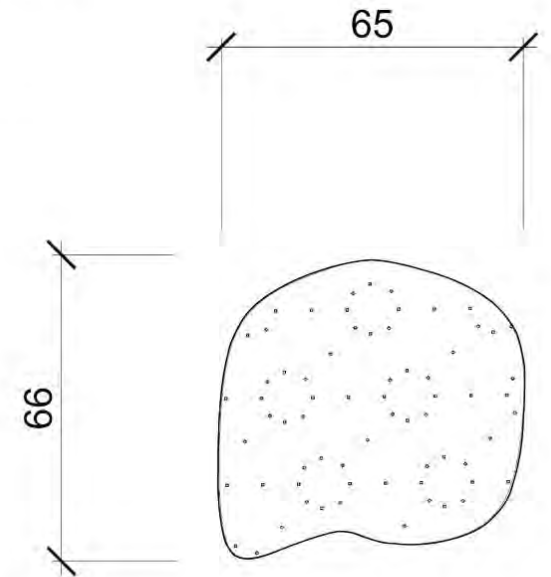
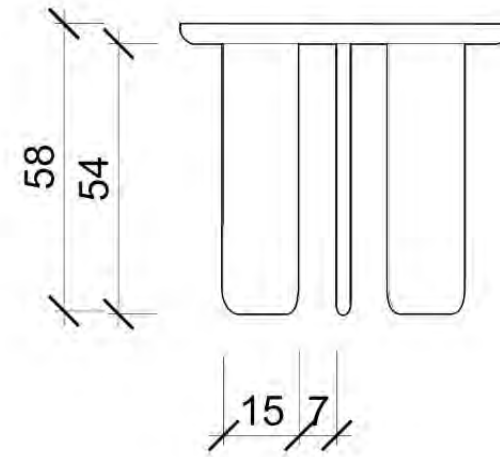

SOFA TABLE

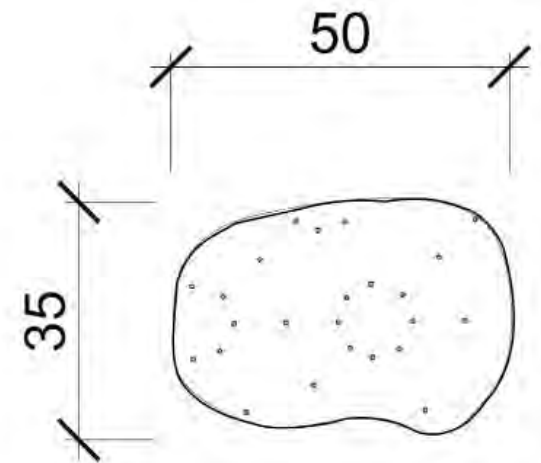
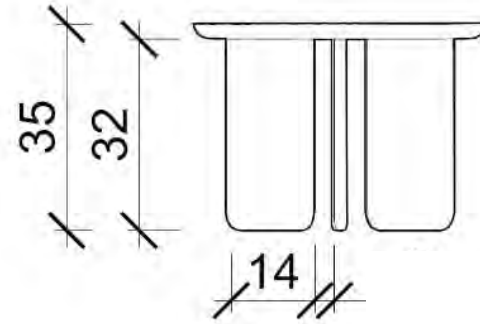

LARGE COFFEE TABLE

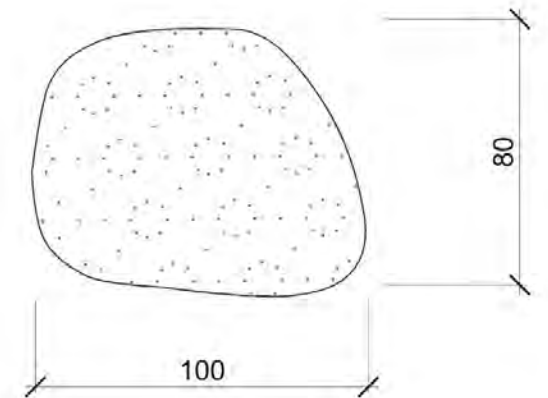
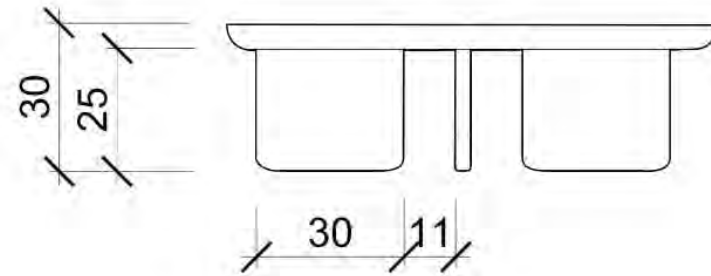

Large Coffee table

CLUSTER

SMALL COFFEE TABLE

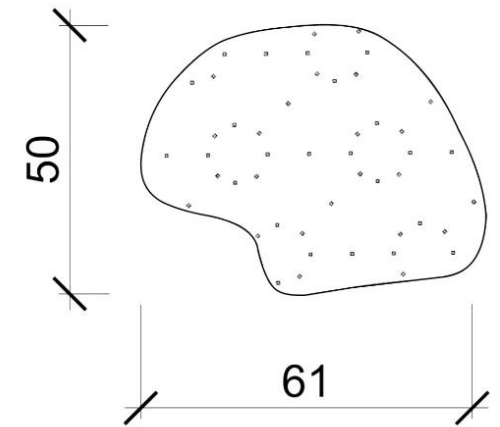
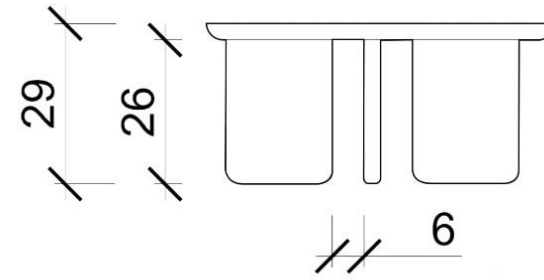

MATERIAL



WHITE OAK

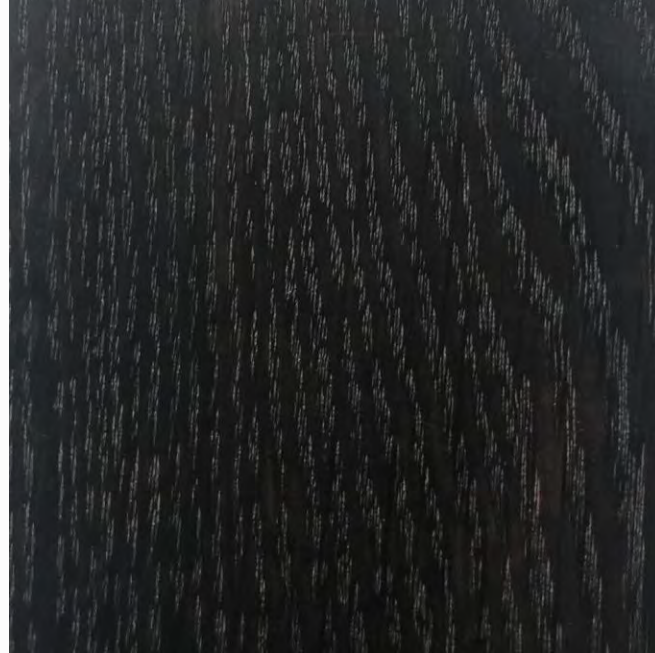

EBONIZED OAK



PLYWOOD







POO
STUDIO

CLUSTER





The background is a textured green surface. Scattered across it are numerous irregular, organic shapes. Some are a dark, muted blue, while others are a light beige or cream color. The shapes vary in size and orientation, creating a sense of movement and depth.

CLUSTER

By Lane S. Preston
Spring 2021
IFD Leonardo Rossano

